



## BATHROOM EXTRACT FANS

# SILENT-100 DESIGN Series

**NEW**

Range of axial extractors with airflow rates of approx. 80 m<sup>3</sup>/h, for connection to 100 mm diameter circular ducting.



Motor mounted on silent-elastic-blocks which absorb the vibrations and allow offering very low noise level. All the fans are manufactured from injection moulded plastic, fitted with automatic shutter and single phase 230V-50Hz, class B low

consumption motor equipped with overload thermal protection. All the fans are class II insulation, **IP45** rated and suitable to operate with air temperature up to 40°C.



SILVER versions can be supplied with an aesthetical silver front grille.



Lp  
**26,5 dB**

**IP45**

consumption  
**8W!**



**SILENT DESIGN 3C**  
Different styles with the bars lights.

SILENT

Axial flow fans

### Back draft shutter



To prevent air entry and limit heat leakage when the extractor is not operating. It opens due to the pressure of the air

### Silent-blocks



Motor mounted on "Silent-elastic-block" to prevent vibration and noise transmission

### Quiet operation

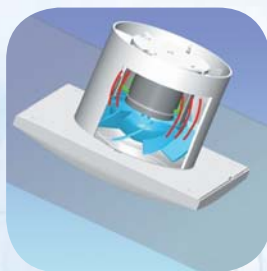

#### SILENT-100 Design

In usual extract fans the vibrations are transmitted to the surrounding areas while in SILENT extractor fans the vibrations are absorbed by the Silent Blocks

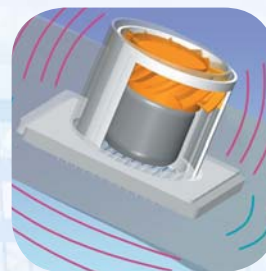

#### Usual extractor

### Models 3C



Interchangeable bar lights let the fan blend in with every setting. 4 colours to match the decor of the room: blue, red, green and yellow.

## Models features

	CZ DESIGN	CRZ DESIGN	CHZ DESIGN	CZ SILVER DESIGN	CRZ SILVER DESIGN	CHZ SILVER DESIGN	CZ DESIGN 3C	CRZ DESIGN 3C	CHZ DESIGN 3C	CZ SILVER DESIGN 3C	CRZ SILVER DESIGN 3C	CHZ SILVER DESIGN 3C
Pilot light	•	•	•	•	•	•	•	•	•	•	•	•
Backdraft shutter	•	•	•	•	•	•	•	•	•	•	•	•
Adjustable Run-On-Timer (1-30min)		•	•		•	•		•	•		•	•
Adjustable humidistat			•			•			•			•
Ball bearings	•	•	•	•	•	•	•	•	•	•	•	•
Silver colour				•	•	•				•	•	•
kit bar lights 4 colours							•	•	•	•	•	•

## Technical characteristics

Model	Abs. power at free discharge (W)	Voltage (V) 50 Hz	Sound pressure level* (dB(A))	Airflow at free discharge (m³/h)	Insulation/ IP	Weight (kg)
SILENT-100 DESIGN	8	230	26,5	80	II / IP45	0,65

\* Sound pressure level measured at 3 m at free air conditions.

## Performance curves

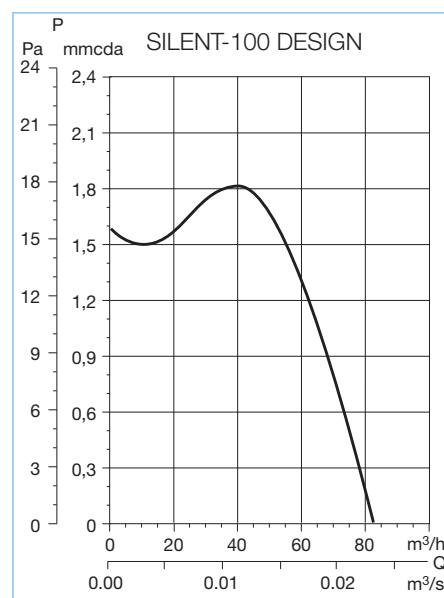

## Dimensions (mm)

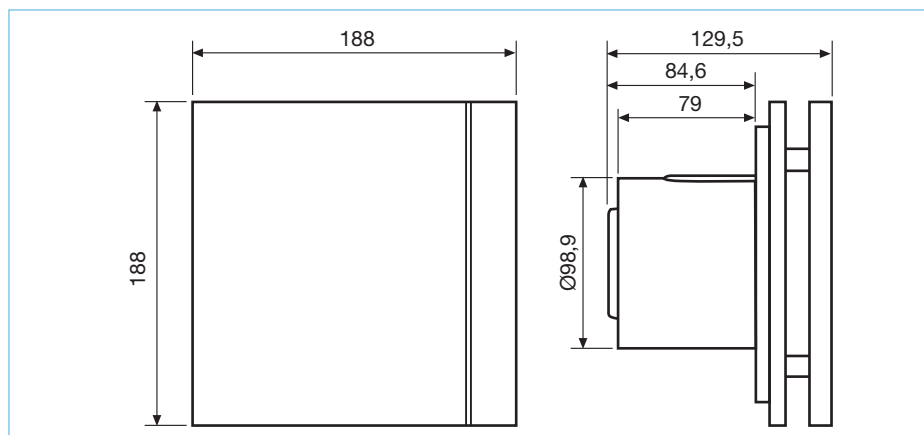

## Accessories



**GSA-100**  
Flexible aluminium ducting



**GRA-70**  
Aluminium exterior grille



**WALL KIT**  
Fixed shutter and telescopic duct (200 to 420 m)



**CX-80/125**  
Worm drive ducting clip



**PER-100W**  
Back draft shutter



**WINDOW KIT**



## BATHROOM EXTRACT FANS

# SILENT-200 DESIGN-3C Series

**NEW**



Range of axial extractors with airflow rates of approx. 175 m<sup>3</sup>/h, for connection to 116 mm diameter circular ducting.

Motor mounted on silent-elastic-blocks which absorb the vibrations and allow offering very low noise level. All the fans are manufactured from injection moulded plastic, fitted with automatic shutter and single phase 230V-50Hz, class B low consumption motor equipped with overload thermal protection. All the fans are class II insulation, **IP45** rated and suitable to operate with air temperature up to 40°C.

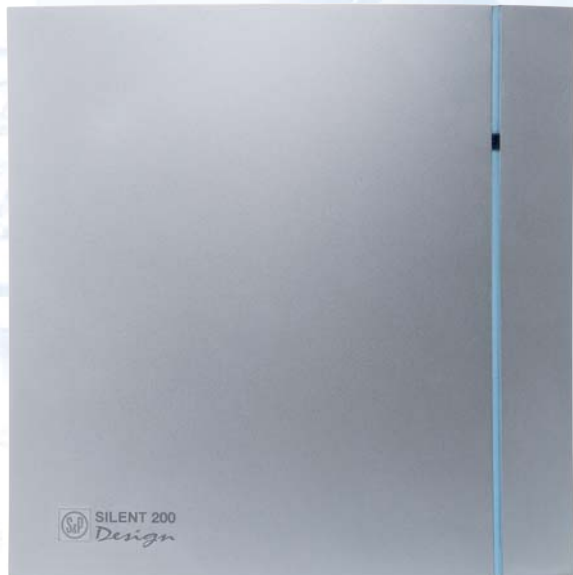

SILVER versions can be supplied with an aesthetical silver front grille.



Lp  
**35 dB**

**IP45**

consumption  
**16W!**



Different styles with the bars lights.

SILENT

Axial flow fans

### Back draft shutter



To prevent air entry and limit heat leakage when the extractor is not operating. It opens due to the pressure of the air.

### Silent-blocks



Motor mounted on "Silent-elastic-block" to prevent vibration and noise transmission.

### Quiet operation

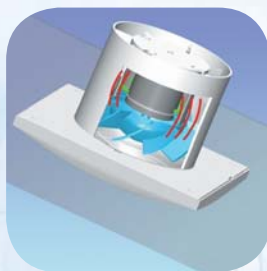

#### SILENT-200 DESIGN-3C

In usual extract fans the vibrations are transmitted to the surrounding areas while in SILENT extractor fans the vibrations are absorbed by the Silent Blocks.

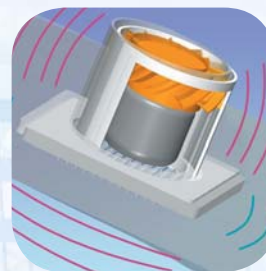

#### Usual extractor

### Interchangeable bar lights



Interchangeable bar lights let the fan blend in with every setting. 4 colours to match the decor of the room: blue, red, green and yellow.

## Models features

	CZ DESIGN 3C	CRZ DESIGN 3C	CHZ DESIGN 3C	CZ SILVER DESIGN 3C	CRZ SILVER DESIGN 3C	CHZ SILVER DESIGN 3C
Pilot light	•	•	•	•	•	•
Backdraft shutter	•	•	•	•	•	•
Adjustable Run-On-Timer (1-30min)		•	•		•	•
Adjustable humidistat			•			•
Ball bearings	•	•	•	•	•	•
Silver colour				•	•	•
kit bar lights 4 colours	•	•	•	•	•	•

## Technical characteristics

Model	Abs. power at free discharge (W)	Voltage (V) 50 Hz	Sound pressure level* (dB(A))	Airflow at free discharge (m <sup>3</sup> /h)	Insulation/ IP	Weight (kg)
SILENT-200 DESIGN-3C	16	230	35	175	II / IP45	0,88

\* Sound pressure level measured at 3 m at free air conditions.

## Performance curves

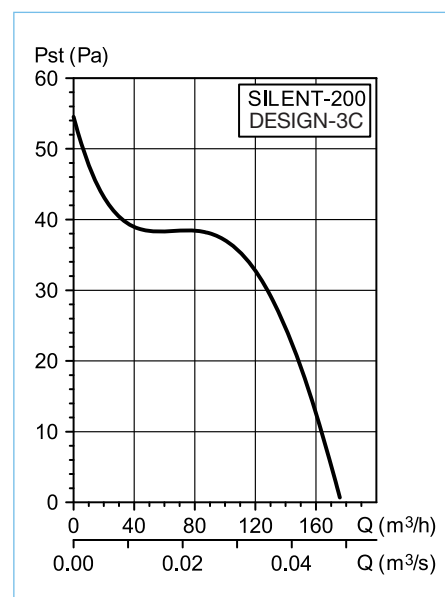

## Dimensions (mm)

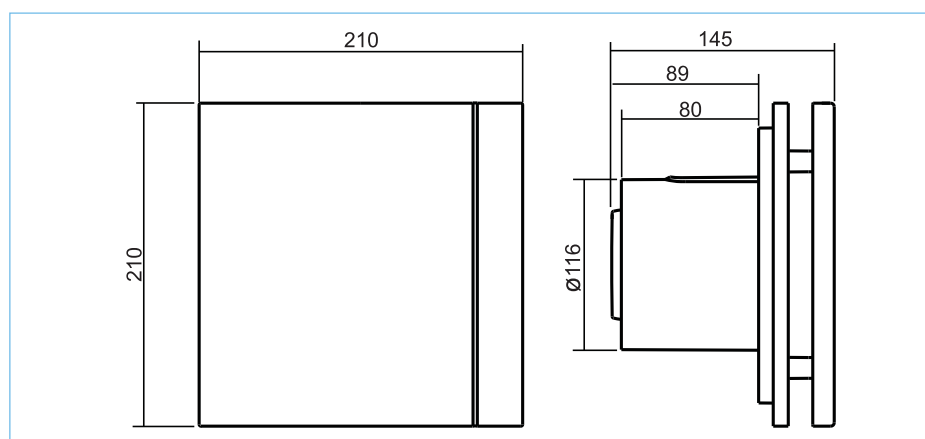

## Accessories



**GSA-100**  
Flexible aluminium ducting



**GRA-70**  
Aluminium exterior grille



**WALL KIT**  
Fixed shutter and telescopic duct (200 to 420 m)



**CX-80/125**  
Worm drive ducting clip



**PER-100W**  
Back draft shutter

